

# MV Series Motors Operation & Parts Manual

**Models M3V, M5V, M5V-US**

*For use with M3V s/n 101058 & above, M3V-US s/n 103013 & above, M5V & M5V-US s/n 102973 & above.*



**FINISH THOMPSON INC.**



**FINISH THOMPSON INC.**  
921 Greengarden Road • Erie, PA 16501-1591 U.S.A.  
Ph 814-455-4478 • Fax 814-455-8518  
Email [fti@finishthompson.com](mailto:fti@finishthompson.com) • [www.finishthompson.com](http://www.finishthompson.com)

## EU Declaration of Conformity



Finish Thompson Inc. hereby declares that the following electrical equipment fully complies with the applicable health and safety requirements as specified by the EU directives listed. The product may not be taken into service until it has been established that the driven Drum and Container Pump complies with the provisions of all relevant EU Directives provided pumps manufactured by Finish Thompson are used.

This declaration is valid provided that the devices are fully assembled and no modifications are made to these devices.

### Type of Device:

Electric Motors for Driving Drum  
and Container Pumps

### Models:

M3V-UK      M5      M5T      M5V      M5X      M10X  
M13      M59P      M59H      S2      S3

### EU Directives (and their applicable amendments):

Low Voltage (2014/35/EU)  
Electromagnetic Compatibility (2014/30/EU)

### Specific standards applied:

EN 60335-1      EN60335-2-41  
EN 55014-1      EN 55014-2  
EN 60529

Signed,

---

Casey D. Bowes  
CEO and President

20 April 2016

Person(s) Authorized to Compile Technical File: Finish Thompson GmbH  
Otto-Hahn-Strasse 16  
Maintal, D-63477 DEU  
Telephone: 49 (0)6181-90878-0

## Introduction

This manual pertains to drum pump motors MV Series. Finish Thompson, Inc. thanks you for choosing our products. We believe the use of our products will be fully satisfactory. When properly installed and operated, your Finish Thompson motor and pump will provide long, trouble-free service; therefore please read this manual carefully before carrying out any operations on the pump-motor unit. Any use other than that described herein is considered incorrect and; consequently, Finish Thompson, Inc. shall not be held responsible for any damages to people or things. In case of doubt or enquiries, please apply to our Technical Service department directly at the following address:

Finish Thompson, Inc.  
921 Greengarden Rd.  
Erie, PA 16501 U.S.A.  
Tel. 1-814-455-4478  
Fax 1-814-455-8518  
[www.finishthompson.com](http://www.finishthompson.com)  
[fti@finishthompson.com](mailto:fti@finishthompson.com)

## Index

Introduction . . . . .	3
General Terms & Conditions, Warranty . . . . .	4
Safety . . . . .	5-7
Installation . . . . .	8
Operation, Specifications & Identification . . . . .	9
Parts . . . . .	10

## **WARRANTY, GENERAL TERMS & CONDITIONS**

1. The following terms and condition apply to the sale of machinery, components and related services and products, of Finish Thompson Inc. (hereinafter “the products”).
2. Finish Thompson Inc. (the manufacturer) warrants only that:
  - a.) its products are free of defects in material, design and workmanship at the time of original purchase
  - b.) its products will function in accordance with Finish Thompson Inc. operation manuals; Finish Thompson Inc. does not guarantee that the product will meet the precise needs of the Customer, except for those purposes set out in any invitation to render documents or other documents specifically made available to Finish Thompson, Inc. before entering into this agreement
  - c.) high quality materials are used in the construction of the pumps and that machining and assembly are carried out to the highest standards. Except as expressly stated above, Finish Thompson, Inc. makes no warranties, express or implied, concerning the products, including all warranties of fitness for a particular purpose.
3. This warranty shall not be applicable in circumstances other than defects in material, design, and workmanship. In particular, this warranty shall not cover the following:
  - a.) Periodic checks, maintenance, repair and replacement of parts due to normal wear and tear;
  - b.) Damage to the product resulting from:
    - i. tampering with, abuse or misuse, including but not limited to failure to use the product for its normal purposes as stated at the time of purchase or in accordance with Finish Thompson, Inc. instructions for use and maintenance of the product, or the installation or improper ventilation or use of the product in a manner inconsistent with the technical or safety standard in force
    - ii. repairs performed by non-authorized service workshop, or opening of the unit by nonauthorized personnel, or use of non genuine Finish Thompson, Inc. parts
    - iii. accidents, acts of God or any cause beyond the control of Finish Thompson, Inc., including but not limited to lightning, water, fire, earthquake, and public disturbances, etc.
4. This warranty shall cover the replacement or repair of any part(s), which is documented to be faulty due to construction or assembling, with a new or repaired part(s) free of charges delivered by Finish Thompson, Inc. Part(s) subjected to normal tear and wear shall not be covered by the warranty. Finish Thompson, Inc. shall decide as to whether the defective or faulty part shall be replaced or repaired. Transportation charge is prepaid to Finish Thompson.
5. The warranty of the products shall be valid for a period of 12 months from the date of delivery, under the condition that notice of the alleged defect to the product(s) or part(s) thereof be given to Finish Thompson Inc. in writing within the term of 8 days from the discovery.
6. Repair or replacement under the terms of the warranty shall not give a right to an extension to, or a new commencement of, the period of warranty. Repair or replacement under the terms of this warranty may be fulfilled with functionally equivalent, reconditioned units. Finish Thompson Inc. qualified personnel shall be solely entitled to carry out repair or replacement of faulty parts after careful examination of the motor. Faulty parts or components when replaced by Finish Thompson Inc. will become the property of Finish Thompson Inc. If this warranty does not apply, the purchaser shall bear all cost for labor, material and transportation.
7. Finish Thompson Inc. will not be liable on any claim, whether in contract, tort, or otherwise, for any indirect, special, incidental, or consequential damages, caused to the customer or to third parties, including loss of profits, process down time, transportation costs, costs associated with replacement or substitution products, labor costs, installation or removal costs. In any and all events, manufacturer’s liability shall not exceed the purchase price of the product and/or accessories.
8. Return Policy. Should you have any problems with this product, please contact the distributor in your area. The distributor will determine if a return to the factory is necessary and will contact the factory for a Return Authorization Number. Otherwise, contact our Technical Service Hotline (1-800-888-3743) or email [techservice@finishthompson.com](mailto:techservice@finishthompson.com) if you have any questions regarding product operation or repair.

## **WARRANTY REGISTRATION**

Thank you for your purchase of this quality Finish Thompson product. Be sure to take a minute to register your pump at [Finishthompson.com/warranty](http://Finishthompson.com/warranty). Simply provide the model number, serial number and a few other pieces of information.

# SAFETY

## 1. Introduction

This manual contains all the information needed for the correct installation, use and maintenance of your new Finish Thompson motor. It should be read and understood by all the personnel involved in installation, operating and servicing of the pump before it is started.

## 2. Operator Qualification and Training

The personnel in charge of the installation, operation and maintenance of the pump unit we produce must be qualified and able to perform the operations described in this manual. Finish Thompson Inc. shall not be held responsible for the training level of personnel and for the fact that they are not fully aware of the contents of this manual.

## 3. Safety Instructions

 **FOR YOUR OWN SAFETY:**

**BEFORE UNDERTAKING ANY SERVICE OPERATION ON YOUR MOTOR OR PUMP, PLEASE MAKE SURE TO WEAR THE PROPER PROTECTIVE GEAR.**

 **GENERAL DANGER**

**NEVER** use a plastic pump or an open, splash-proof, TEFC or non-ATEX motor when pumping or mixing flammable or combustible material.

**ALWAYS** use and store the pump and motor in an upright position.

 **DANGER: POWER SUPPLY**

**NEVER** perform any maintenance operation on the motor while it is running or before it has been disconnected from the power supply. Avoid any possible hazard that might be caused by electric power.

**ALWAYS** check the electrical specifications on the motor data plate and make sure they correspond to the power supply to which it will be connected.

**ALWAYS** place motor in the OFF position prior to connecting the power source.

**NEVER** immerse the motor in liquid.

## 4. Noise Level

MV Motors in normal operating conditions produce a sound level equal or less than 79 dBA at a distance of three feet (~ one meter).

## 5. Modifications and Spare Parts

Any changes concerning the service of the motor as originally purchased, can be executed only after written approval from Finish Thompson Inc. It is recommended to use only genuine Finish Thompson Inc. spare parts and approved accessories. The use of non original spare parts or non approved accessories will void warranty and removes any responsibility on our behalf for any damage caused to people or things.

## Sécurité

### 1. Introduction

Ce manuel donne toutes les instructions nécessaires pour assurer l'installation, l'utilisation et l'entretien adéquats du moteur de pompe Finish Thompson. Ces instructions doivent être lues et comprises par tout le personnel participant à l'installation, à l'utilisation et à l'entretien de la pompe avant son démarrage.

### 2. Qualifications et formation des opérateurs

Le personnel en charge de l'installation, de l'utilisation et de l'entretien de la pompe et de son moteur doit être qualifié et capable d'effectuer les tâches décrites dans ce manuel. Finish Thompson Inc. n'est pas responsable du niveau de formation du personnel et du fait qu'ils n'aient pas pris entièrement connaissance du contenu de ce manuel.

### 3. Consignes de sécurité

#### **POUR VOTRE SÉCURITÉ**

AVANT d'utiliser ou de faire l'entretien de votre pompe, s'assurer de porter les vêtements protecteurs adéquats, les protections oculaires (pour les yeux) et de suivre les procédures de sécurité standard pour manipuler les matières corrosives ou dangereuses pour la santé.

#### **DANGERS GÉNÉRAUX**

**NE JAMAIS** utiliser de pompe en plastique ni de moteur ouvert, étanche aux éclaboussures, de type TEFC ou non conforme à la norme ATEX, pour pomper ou mélanger des matières inflammables ou combustibles.

**TOUJOURS** utiliser et remiser la pompe et le moteur en position verticale.

#### **DANGER : ALIMENTATION ÉLECTRIQUE**

**NE JAMAIS** effectuer aucune tâche d'entretien sur le moteur lorsqu'il est en marche, ou avant de le débrancher de son alimentation électrique. Éviter toute condition dangereuse en rapport avec l'alimentation électrique.

 **TOUJOURS** vérifier les spécifications électriques sur la plaque signalétique du moteur et s'assurer qu'elles correspondent à l'alimentation électrique à laquelle il est raccordé.

**TOUJOURS** mettre le moteur en position d'arrêt («OFF») avant de le raccorder à l'alimentation électrique.

**NE JAMAIS** immerger le moteur dans un liquide.

### 4. Niveau de bruit

En conditions normales d'utilisation, les moteurs électriques M3V, M5V et M5V-US génèrent un niveau de bruit égal ou inférieur à 79 dBA à une distance de 3 pieds (env. 1 mètre).

### 5. Modifications et pièces de rechange

Toute modification concernant l'entretien du moteur/pompe, tels qu'achetés initialement, peut être exécutée seulement après en avoir obtenu l'autorisation écrite de Finish Thompson Inc. On demande d'utiliser seulement les pièces de rechange originales de Finish Thompson Inc. et les accessoires approuvés. Le fait de ne pas utiliser les pièces de rechange originales de Finish Thompson Inc. ou les accessoires approuvés annulera la garantie et dégagera le fabricant de toute responsabilité liée aux blessures ou dommages matériels.

## IMPORTANT SAFETY INFORMATION FOR PUMPING FLAMMABLE OR HAZARDOUS SUBSTANCES

Read these instructions before operating the pump and motor equipment. The manufacturer will not be responsible for any damage to property or to persons caused by improper use of the equipment.

**⚠ WARNING:** It is the responsibility of the user to operate the pump in conformance with OSHA rules for dispensing liquids. Pump containers should be grounded when using with flammable or combustible liquids to avoid static electricity.

1. Use only an explosion-proof rated electric or non-electric (air) motors on stainless steel pump tubes with a Static Protection Kit when transferring flammable or combustible liquids.

**⚠ WARNING:** Never use an open, splash-proof, TEFC, battery-operated or non-explosion-proof rated motor or a plastic pump tube when transferring flammable or combustible liquids.

2. When operating a drum pump (especially when pumping flammable, combustible or hazardous liquids) follow all electrical and safety codes.

a) In the United States: the United States Occupational Safety and Health Act (OSHA), most recent National Electrical Code (NEC), National Fire Protection, Inc. (NFPA) Code 30 (Flammable and Combustible Code), NFPA 77 (Static Electricity), NFPA 251 (Standard Method of fire Test of Building Construction), NFPA 704 (Identification of the Fire Hazards of Materials), and other NFPA codes, local codes and ordinances.

b) Outside the United States: the ATEX equipment directive 2014/34/EU where applicable, the ATEX workplace 99/92/EC directive where applicable, in addition the precautions of the U.S. codes listed herein and all other local codes and ordinances.

3. Pumping hazardous, flammable, or combustible liquids should only be done in buildings, rooms, or areas suited for this purpose. (See NFPA 30, NFPA 78, NFPA 80, NFPA 251, NFPA 704, other suitable NFPA codes, OSHA, ATEX workplace 99/92/EC directive insurance companies, and other local codes and ordinances.)

4. When filling cans, drums, etc. with combustible or flammable liquids, both container pumping from and container pumping to, should be bonded and grounded to dissipate possible accumulations of static electricity, and minimize sparks caused by static electricity (refer to NFPA 77 and CLC/TR 60079-32-1 for specific details).

**⚠ WARNING:** Avoid splashing. Splash filling can create static electricity and is extremely hazardous. Reduce motor speed to prevent splashing.

**⚠ WARNING:** Fluid velocity must be 3 feet/.9 meter/second maximum (7 gpm/26.5 lpm in 1" hose and 4 gpm/15 lpm in ¾" hose) to reduce risk of static electricity. Reduce motor speed to reduce the fluid velocity.

5. Before using, confirm that the pump and any accessories (hose, nozzle, flow meter, etc.) materials of construction are suitable for the material to be pumped and that the maximum temperature is not exceeded.

## INFORMATIONS IMPORTANTES SUR LA SÉCURITÉ DURANT LE POMPAGE DE SUBSTANCES INFLAMMABLES OU DANGEREUSES

Veuillez lire attentivement ces instructions avant d'utiliser la pompe et l'équipement du moteur. Le fabricant ne sera pas tenu responsable des dommages matériels ou corporels causés par une utilisation inappropriée de l'équipement.

**⚠ AVERTISSEMENT:** Il est de la responsabilité de l'utilisateur de faire fonctionner la pompe conformément aux règles OSHA (Santé et Sécurité au Travail) relatives à la distribution de liquides. Les conteneurs de pompes doivent être électriquement mis à la terre lors de l'utilisation de liquides inflammables ou combustibles afin d'éviter toute électricité statique.

1. Lors du transfert de liquides inflammables ou combustibles, utilisez uniquement des moteurs électriques ou non électriques (pneumatiques) antidéflagrants sur des tubes de pompe en acier inoxydable dotés d'un dispositif de protection antistatique.

**⚠ AVERTISSEMENT:** N'utilisez jamais de moteur ouvert, à l'épreuve des éclaboussures, TEFC, alimenté par piles ou non antidéflagrant, ni un tube de pompe en plastique lors du transfert de liquides inflammables ou combustibles.

2. Lors de l'utilisation d'une pompe à tambour (en particulier lors du pompage de liquides inflammables, combustibles ou dangereux), respectez tous les codes électriques et les codes de sécurité.

a) Aux États-Unis : Loi américaine sur la sécurité et la santé au travail (OSHA); le code national de l'électricité (NEC) le plus récent; le code 30 de la NFPA (code d'inflammabilité et de produits combustibles); le code NFPA 77 (électricité statique); le code NFPA 251 (Méthode standard de test d'incendie de la construction de bâtiments); le code NFPA 704 (Identification des risques d'incendie des matériaux) et autres codes et règlements de la NFPA.

b) En dehors des États-Unis : La directive sur les équipements ATEX 2014/34 / EU, le cas échéant, la directive ATEX sur le lieu de travail 99/92 /EC, le cas échéant, ainsi que les précautions des codes des États-Unis énumérés dans la présente et de tous les autres codes, lois et règlements locaux.

3. Le pompage de liquides dangereux, inflammables ou combustibles ne doit être effectué que dans des bâtiments, des pièces ou des zones adaptées à cet usage. (Voir NFPA 30, NFPA 78, NFPA 80, NFPA 251, NFPA 704, autres codes NFPA appropriés, OSHA, les directives des compagnies d'assurance ATEX 99/92 /CE, et autres codes, lois et règlements locaux.)

4. Lors du remplissage de bidons, fûts, etc. avec des liquides combustibles ou inflammables, les conteneurs d'où le liquide est pompé et le conteneur recevant le liquide doivent être reliés et mis à la terre pour éviter toute accumulation éventuelle d'électricité statique et minimiser ainsi les étincelles causées par l'électricité statique (voir NFPA 77). et CLC / TR 60079-32-1 pour des détails spécifiques).

**⚠ AVERTISSEMENT:** Évitez les éclaboussures. Les éclaboussures peuvent créer de l'électricité statique et sont extrêmement dangereuses. Réduisez la vitesse du moteur pour éviter les éclaboussures.

**⚠ AVERTISSEMENT:** La vitesse du fluide doit être au maximum de 3 pieds / 0,9 mètre / seconde (7 gpm / 26,5 lpm dans un tuyau de 1"; et 4 gpm / 15 lpm dans un tuyau de ¾") afin de réduire le risque d'électricité statique. Réduisez la vitesse du moteur afin de réduire ainsi la vitesse du fluide.

5. Avant utilisation, assurez-vous que les matériaux de la pompe et des accessoires (tuyau, ajutage, débitmètre, etc.) sont compatibles avec le fluide et que la température maximale n'est pas dépassée.

## INSTALLATION

1. Unpack motor from carton. Check for shipping damage. If damage is detected, save the packaging and notify the carrier immediately.
2. Loosen the nut on the motor housing by turning it counterclockwise (as viewed from the bottom of the motor). Note that the nut remains on the motor even when loosened. See figure 1.
3. Looking into the bottom/drive-end of the motor, align the coupling half with the coupling half orientation of the pump. Aligning the coupling half with two of the slots in the motor adapter sleeve is recommended to provide a reference point. See figures 2 & 3.
4. Make sure that the rubber coupling insert (provided with the pump) is properly installed in the pump coupling half.
5. With the motor coupling half properly aligned, firmly push the motor down over the pump head until fully engaged. See figure 3.
6. The motor isn't fully coupled unless the bottom of the motor and the top of the pump are completely flush. See figure 4.

**⚠ Warning:** Do not position the motor handle and cord over and in front of the pump discharge. Position it in line with the discharge or at 90° to the discharge.

7. Manually tighten the nut by turning it clockwise until secure. See figure 5.

**Note:** Do not use hand tools to tighten the nut as this may cause damage to the motor casing.

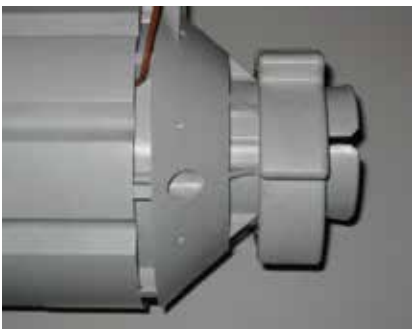

Figure 1



Figure 2



Figure 3



Figure 4





Figure 5



## OPERATION

The MV Series motors incorporate an ON/OFF switch as well as a Variable Speed Control. When operating the MV Series for the first time it is recommended to turn down the speed control (Counter Clockwise) to the lowest setting. Insert the pump tube into the fluid to be dispensed and the discharge hose into the container to be filled. Make sure the discharge hose is properly secured. Turn on the motor with the ON/OFF switch & adjust the speed control to the desired flow rate. Both of these operations can be done with the same hand being used to support the pump utilizing the thumb. Keep in mind that flow rates will vary depending upon fluid viscosity & specific gravity. It may be necessary to operate the pump at a lower speed for high viscosity fluids. Contact factory for troubleshooting tips.

<b>Motor Specifications</b>			
Model	<b>M3V</b>	<b>M5V</b>	<b>M5V-US</b>
Part Number	106655	106658	106657
Nominal Voltage	115v	230v	230v
Input Power HP / Watts	.8 / 650	.8 / 650	.8 / 650
Hertz	50 / 60		
RPM's (Variable Speed)	3,500-10,000		
Enclosure	3(WP) Splash-Proof	IP24 Splash-Proof	
Certificates or Approvals			
Max Viscosity cps / Density	500 / 1.8		
Duty Cycle	Continuous *		
Applicable Pump Models	PF / TB / TBP		

\*Contact Factory for brush life information.

## MOTOR IDENTIFICATION

(M3V Sample Label)



**FINISH THOMPSON INC.**

921 Greengarden Road • Erie, PA 16501-1591 U.S.A.  
Ph 814-455-4478 • Fax 814-455-8518  
Email [fti@finishthompson.com](mailto:fti@finishthompson.com) • [www.finishthompson.com](http://www.finishthompson.com)

Model: M3V  
 Part No: 106655  
 Serial No.: 12345-A09  
 Output: 4/5 HP, 115 VAC, 50/60 Hz  
 Enclosure: 3 (WP) Splashproof  
 LR157411 Thermally Protected  
 Date of Manufacture: 3/31/2009



# PARTS

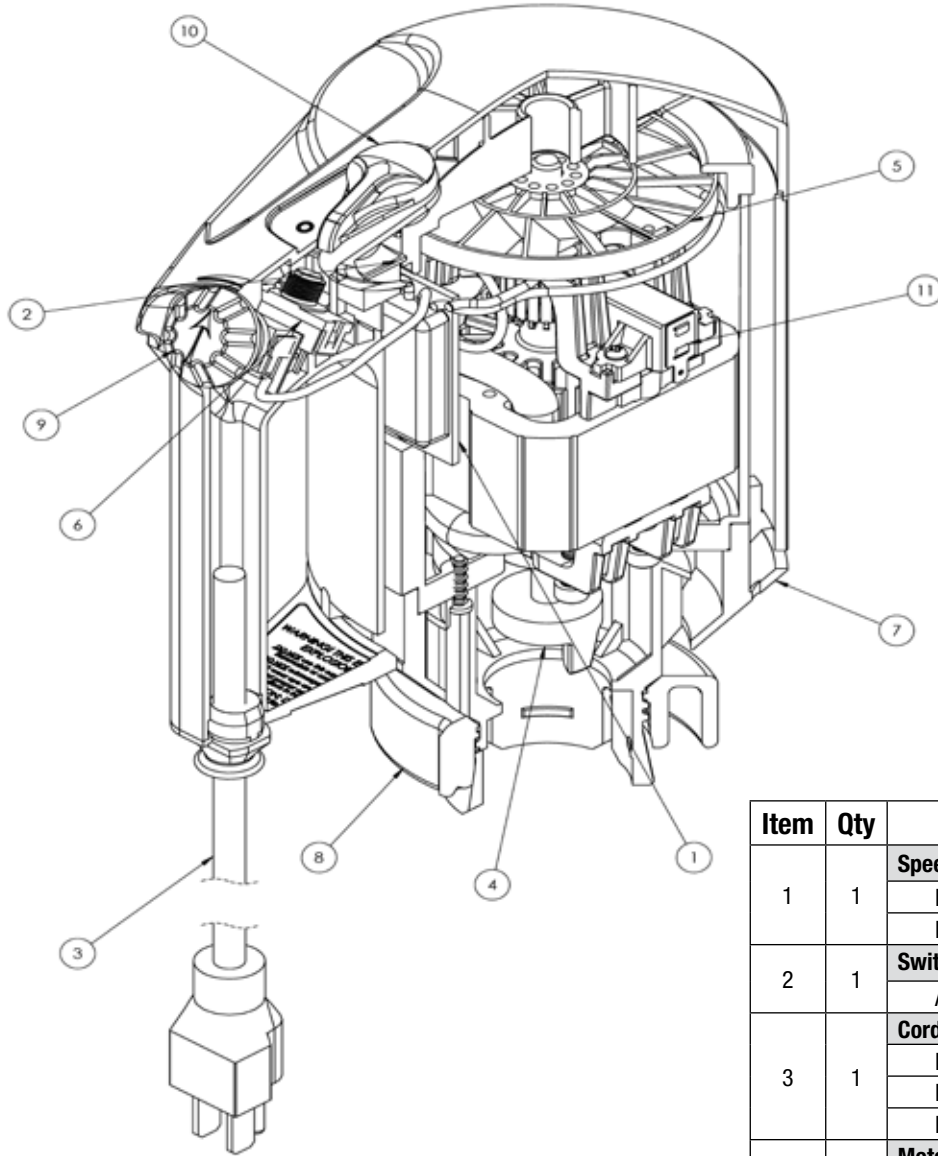

Note: Housing Repair Kit includes handle, cover, base, nut and labels.

Item	Qty	Description	Part Number
1	1	<b>Speed Control Assy</b>	
		M3V	108322-1
		M5V	108322-2
2	1	<b>Switch, On\Off</b>	
		All models	106029
3	1	<b>Cord</b>	
		M3V, 115 volt	106648
		M5V-US, 230 volt	106665
		M5V, 230 volt	106666
4	1	<b>Motor Coupling</b>	
		All models	J100012-2
5	1	<b>Fan Blade</b>	
		All models	106027
6	1	<b>Circuit Breaker</b>	
		M3V	108321
		M5V, M5V-US	107064
7	1	<b>Housing Repair Kit</b>	
		All models	108376
8	1	<b>Housing Nut</b>	
		All models	106541
9	1	<b>Speed Control Knob</b>	
		All models	106538
10	1	<b>On/Off Switch Knob Assembly</b>	
		All models	107225
11	1	<b>Brush Kit</b>	
		M3V	108385-1
		M5V	108385-2



## FINISH THOMPSON INC.

921 Greengarden Road • Erie, PA 16501-1591 U.S.A.  
 Ph 814-455-4478 • Fax 814-455-8518  
 Email [fti@finishthompson.com](mailto:fti@finishthompson.com) • [www.finishthompson.com](http://www.finishthompson.com)

Tech Service 1-800-888-3743  
[techservice@finishthompson.com](mailto:techservice@finishthompson.com)  
 Part No. 106237, R3, 3/8/2019