

KC Series

MAGNETIC SEALLESS PUMPS

KC22 & 32 Sealless* Centrifugal Pumps 3.0 to 10 HP (1.5 to 7.5 kW)

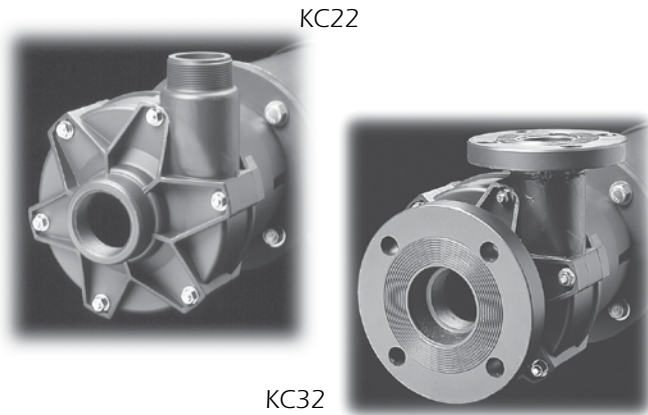

Features

- 10-minute run-dry capability with carbon bushing
- Polypropylene (P) or PVDF (V)
- Excellent chemical resistance
- Accepts standard NEMA 184TC, 213TC or IEC 90, 100, 112 motor frames
- NPT or BSP threads or flanged connections
- Rugged cantilevered ceramic spindle
- Service friendly back pull-out design
- Up to 1.8 specific gravity
- 50 cP maximum viscosity
- Open and closed impeller options

Performance

60 Hz, 3450 rpm - KC22 & 32, Open & Closed Impellers

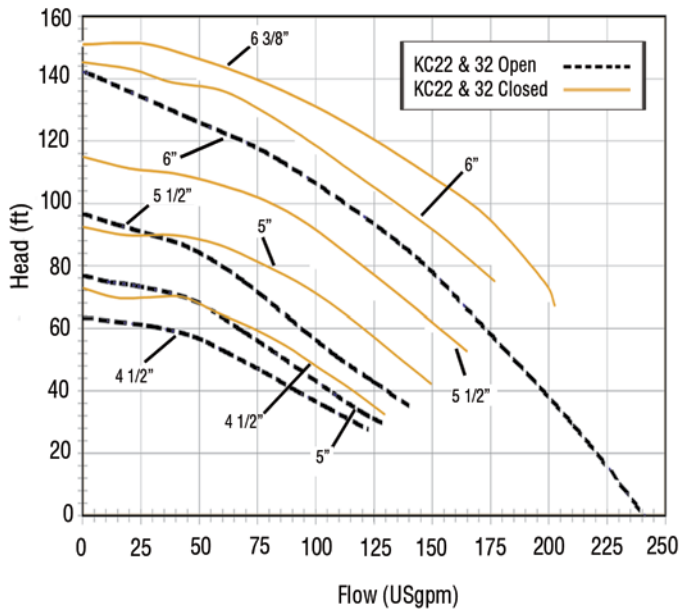

50 Hz, 2900 rpm - KC22 & 32, Open & Closed Impellers

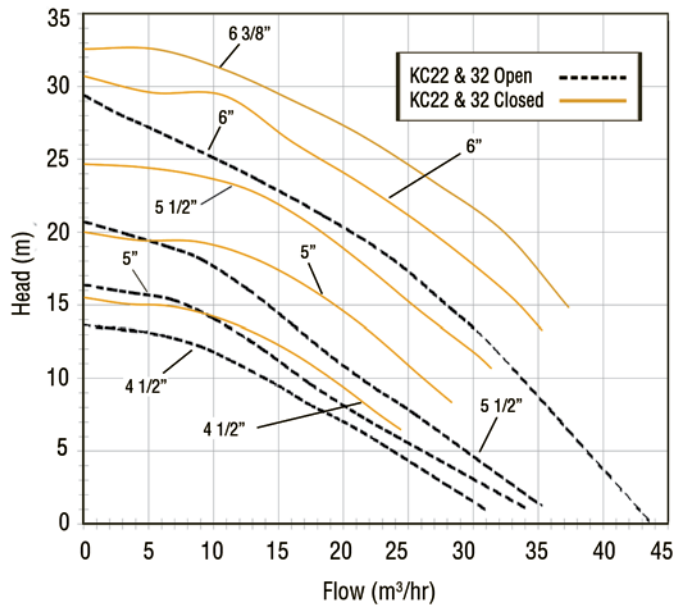

Specifications

Open Impeller

MODEL (CONSTRUCTION)	SUCTION DISCHARGE	IMPELLER SIZE		MAX. FLOW		MAX. HEAD		MOTOR DRIVE		MAX.
		inch	cm	3450 rpm gpm	2900 rpm m ³ /hr	3450 rpm ft	2900 rpm m	3450 rpm hp	2900 rpm kw	S.G. @ 50 cps
KC22/3245 (P, V)	2" FNPT	4.5	11.5	180	32.7	63	13.6	3.0 - 5.0	1.5 - 2.2	1.8
KC22/3250 (P, V)	2" MNPT	5.0	12.7	200	36.2	77	16.4	5.0 - 7.5	2.2 - 4.0	1.8
KC22/3255 (P, V)	3" Flange	5.5	14.0	205	37.1	97	20.7	5.0 - 7.5	2.2 - 4.0	1.8
KC22/3260 (P, V)	2" Flange	6.0	15.2	241	43.8	142	29.4	7.5 - 10.0	4.0 - 5.5	1.3

Closed Impeller

MODEL (CONSTRUCTION)	SUCTION DISCHARGE	IMPELLER SIZE		MAX. FLOW		MAX. HEAD		MOTOR DRIVE		MAX.
		inch	cm	3450 rpm gpm	2900 rpm m ³ /hr	3450 rpm ft	2900 rpm m	3450 rpm hp	2900 rpm kw	S.G. @ 50 cps
KC22/3245 (P, V)	2" FNPT	4.5	11.5	129	24.4	73.1	15.5	3.0 - 5.0	1.5 - 3.0	1.8
KC22/3250 (P, V)	2" MNPT	5.0	12.7	149	28.3	92.4	20.0	5.0 - 7.5	3.0 - 4.0	1.8
KC22/3255 (P, V)	3" Flange	5.5	14.0	165	31.4	115.1	24.7	5.0 - 7.5	3.0 - 4.0	1.8
KC22/3260 (P, V)	2" Flange	6.0	15.2	193	35.3	141.8	30.7	7.5 - 10.0	4.0 - 5.5	1.3
KC22/3263 (P,V)		6.375	16.2	201	37.3	150.7	32.6	7.5 - 10.0	4.0 - 5.5	1.0

Dimensions Close Coupled

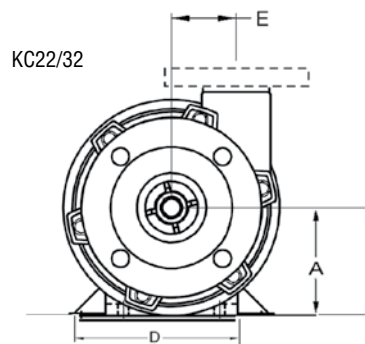
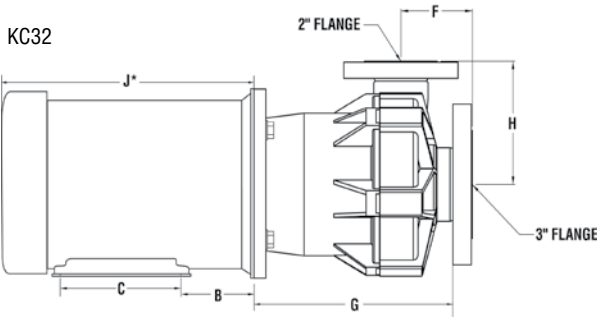
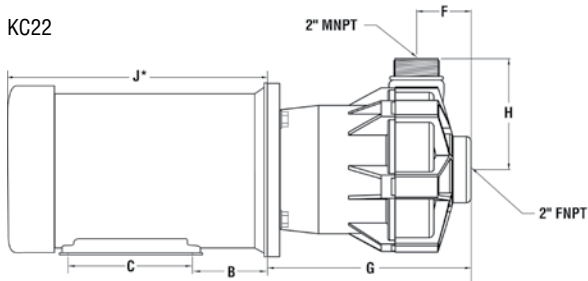

With NEMA TEFC Motors (Inches)

MODEL	MOTOR FRAME	A	B	C	D	E	F	G	H	J*
KC22	184TC	4-1/2	2-3/4	5-1/2	7-1/2	2-11/16	2-11/16	10-11/16	5-15/16	13-15/16
	213TC	5-1/4	3-1/2		8-1/2			11-3/16		15-9/16
KC32	184TC	4-1/2	2-3/4	5-1/2	7-1/2	2-11/16	3-5/8	11-1/2	5-15/16	13-15/16
	213TC	5-1/4	3-1/2		8-1/2			12-1/32		15-9/16

With IEC Motors (Millimeters)

MODEL	MOTOR FRAME	A	B	C	D	E	F	G	H	J*
KC22	90	90	56	100	140	68.3	68.3	261.2	150.8	292
	100	100	63		160	68.3	68.3	255.6		331
	112	112	70		190					366
KC32	90	90	56	140	140	68.3	92.1	285	150.8	292
	100	100	63		160	68.3	92.1	277		331
	112	112	70		190					366

*Varies with manufacturer



FINISH THOMPSON INC.

921 Greengarden Road • Erie, PA 16501-1591 U.S.A.
Ph 814-455-4478 • Fax 814-455-8518
Email fti@finishthompson.com • www.finishthompson.com

Toll Free USA & CANADA 1-800-934-9384
Literature I.D. No. - FT98-706G, 10/26/09

