

GP SERIES CURVEBOOK

Effective 12-1-03
Literature ID Number FT03-890, Rev. 0

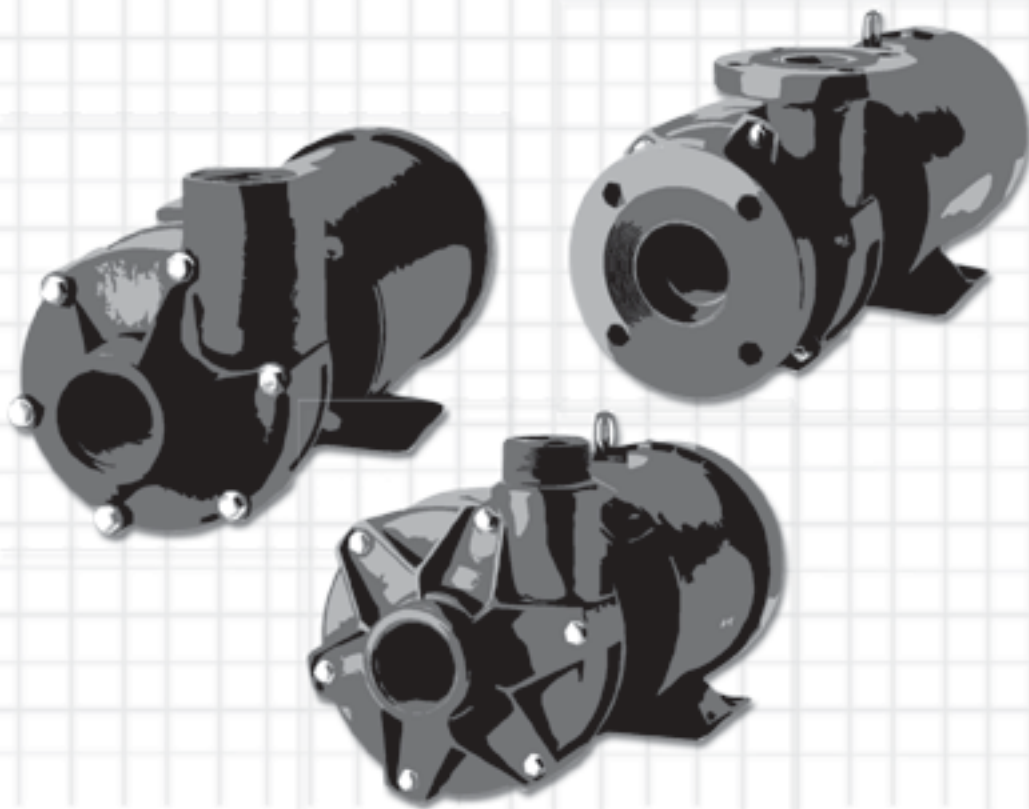
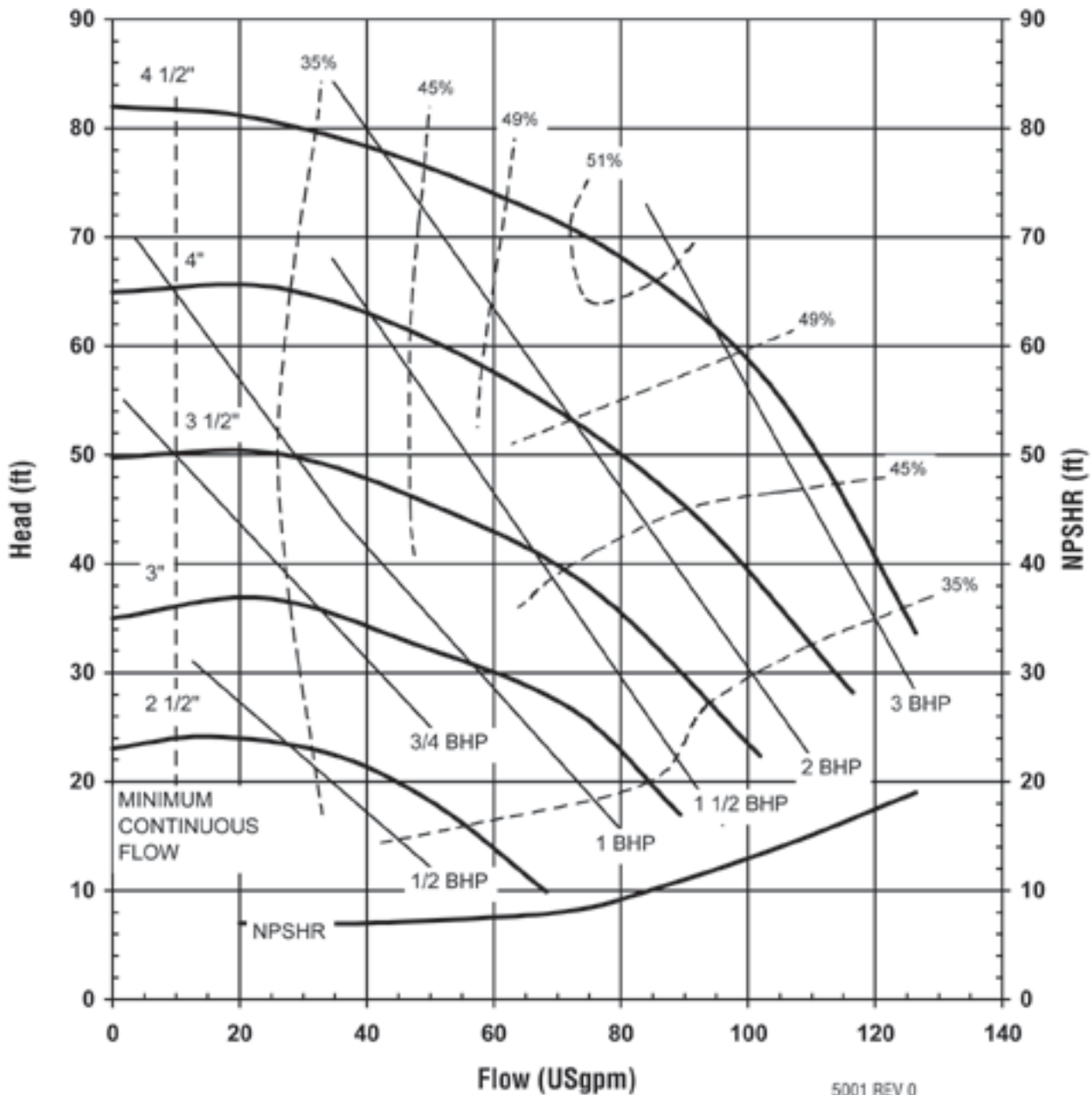

TABLE OF CONTENTS

GP11, 3450 rpm, 60 Hz	4
GP11, 1725 rpm, 60 Hz	5
GP11, 2900 rpm, 50 Hz	6
GP11, 1450 rpm, 50 Hz	7
GP22/32, 3450 rpm, 60 Hz	8
GP22/32, 1725 rpm, 60 Hz	9
GP22/32, 2900 rpm, 50 Hz	10
GP22/32, 1450 rpm, 50 Hz	11

MODEL GP11

3450 rpm, 60 Hz
Suction: 1 1/2" FNPT
Discharge: 1 1/2" FNPT



5001 REV 0
08/06/03

MODEL GP11

1725 rpm, 60 Hz
Suction: 1 1/2" FNPT
Discharge: 1 1/2" FNPT

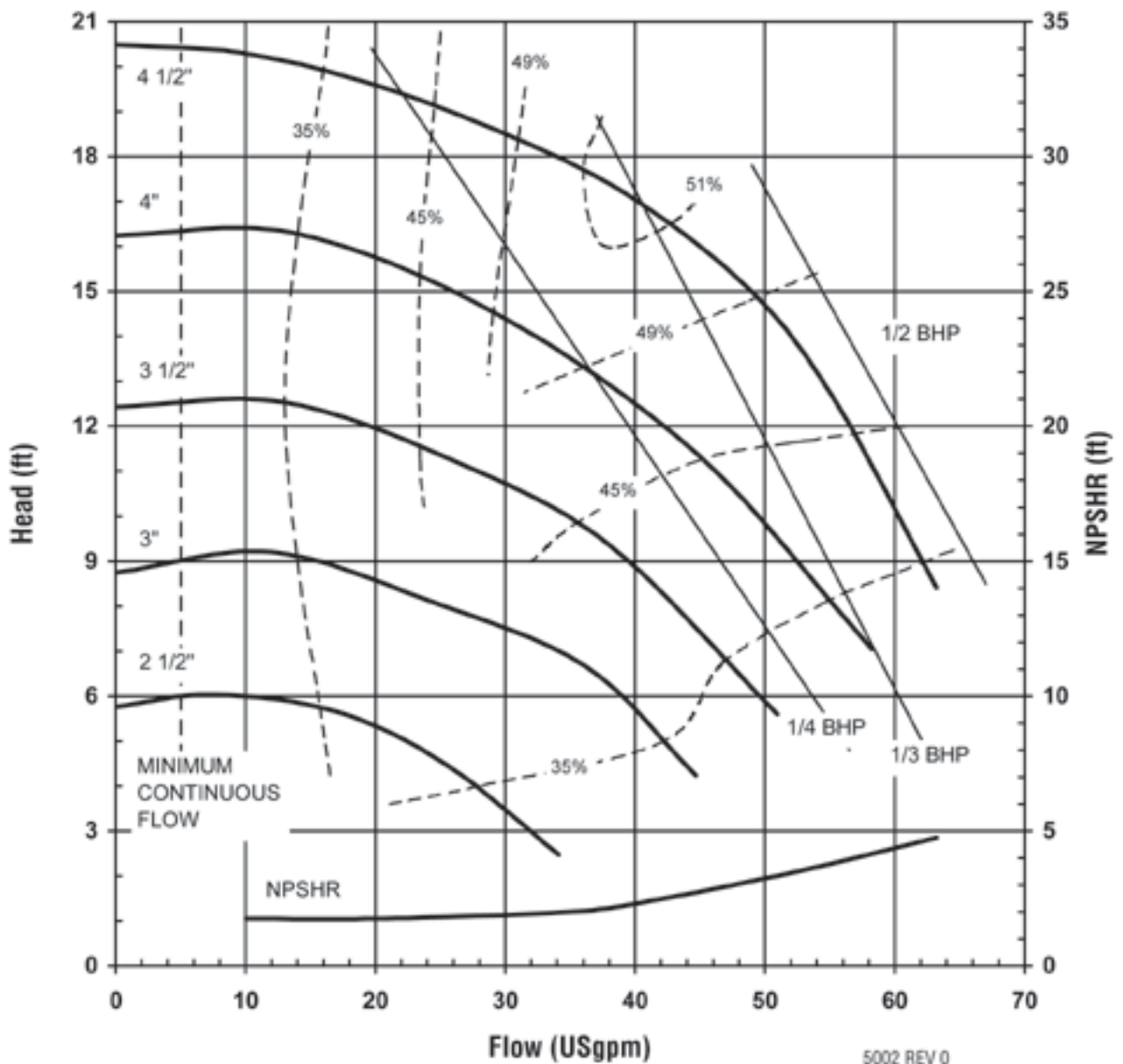

5002 REV 0
08/06/03

MODEL GP11

2900 rpm, 50 Hz
Suction: 1 1/2" FNPT
Discharge: 1 1/2" FNPT

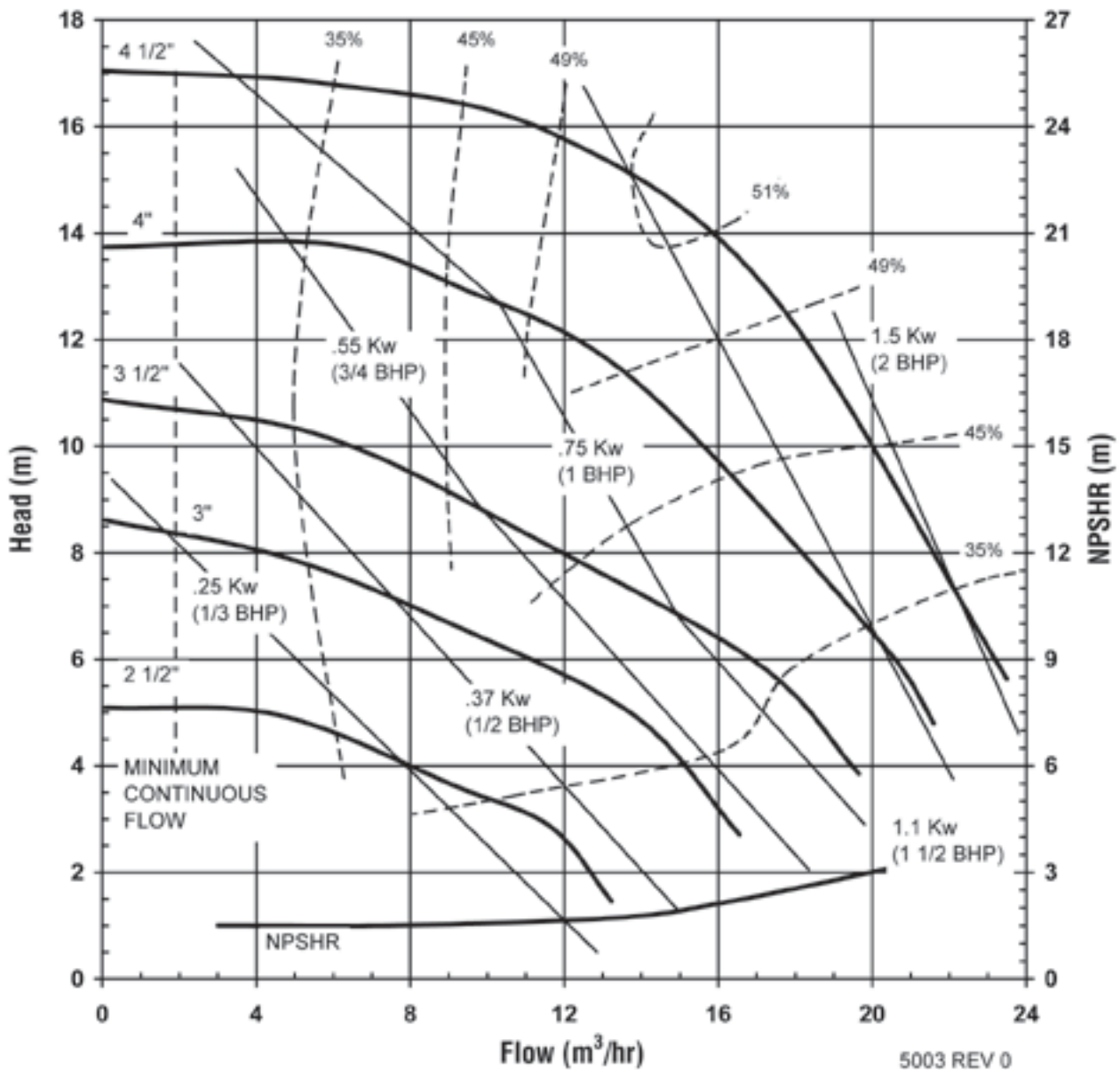

MODEL GP11

1450 rpm, 50 Hz
Suction: 1 1/2" FNPT
Discharge: 1 1/2" FNPT

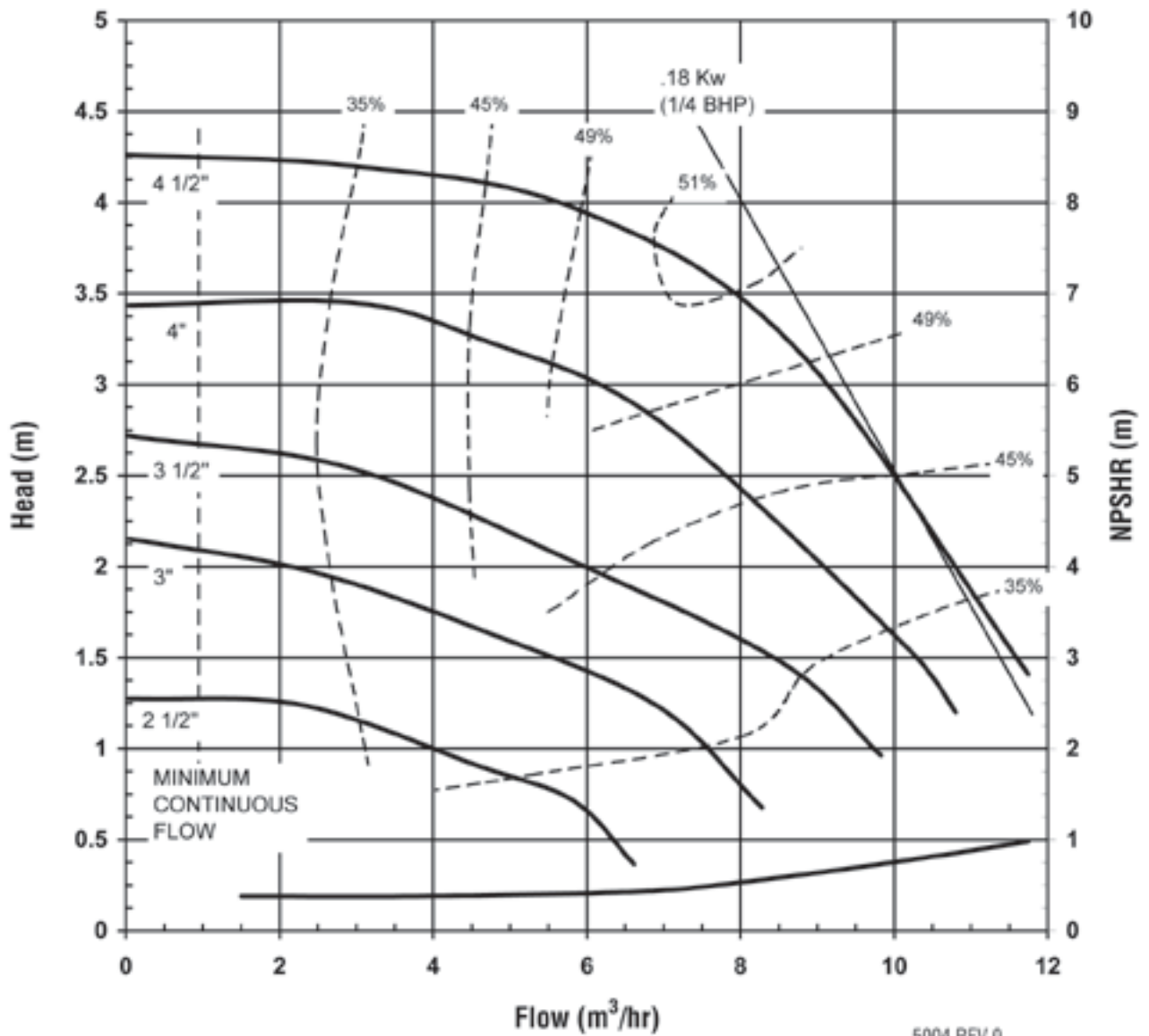

5004 REV 0
08/06/03

MODEL GP22/32

3450 rpm, 60 Hz

Suction: 2" FNPT/3" FLANGE

Discharge: 2" MNPT/2" FLANGE

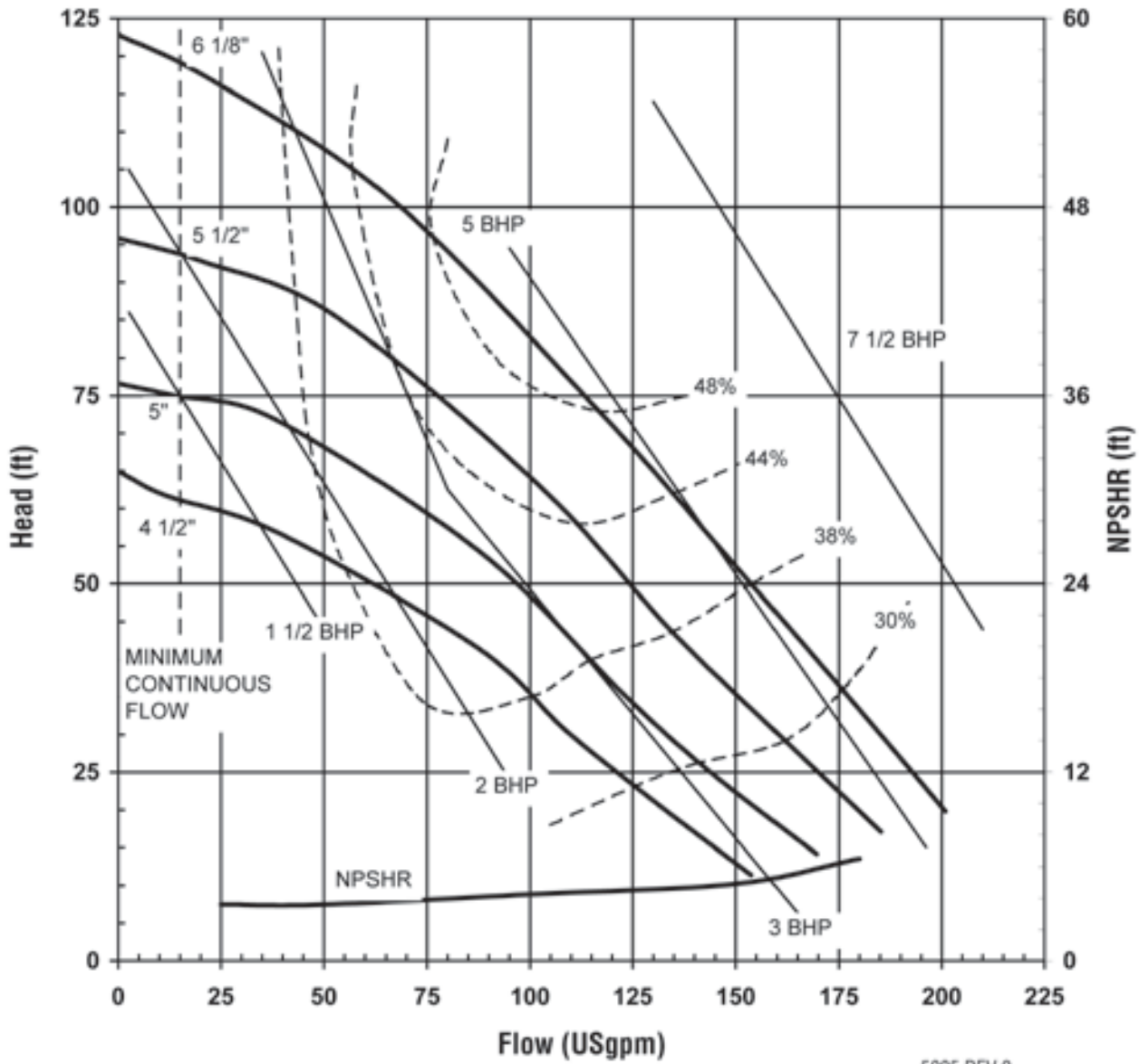

5005 REV 0
08/28/03



**GP SERIES
STANDARD
PERFORMANCE CURVE**

MODEL GP22/32

1725 rpm, 60 Hz

Suction: 2" FNPT/3" FLANGE

Discharge: 2" MNPT/2" FLANGE

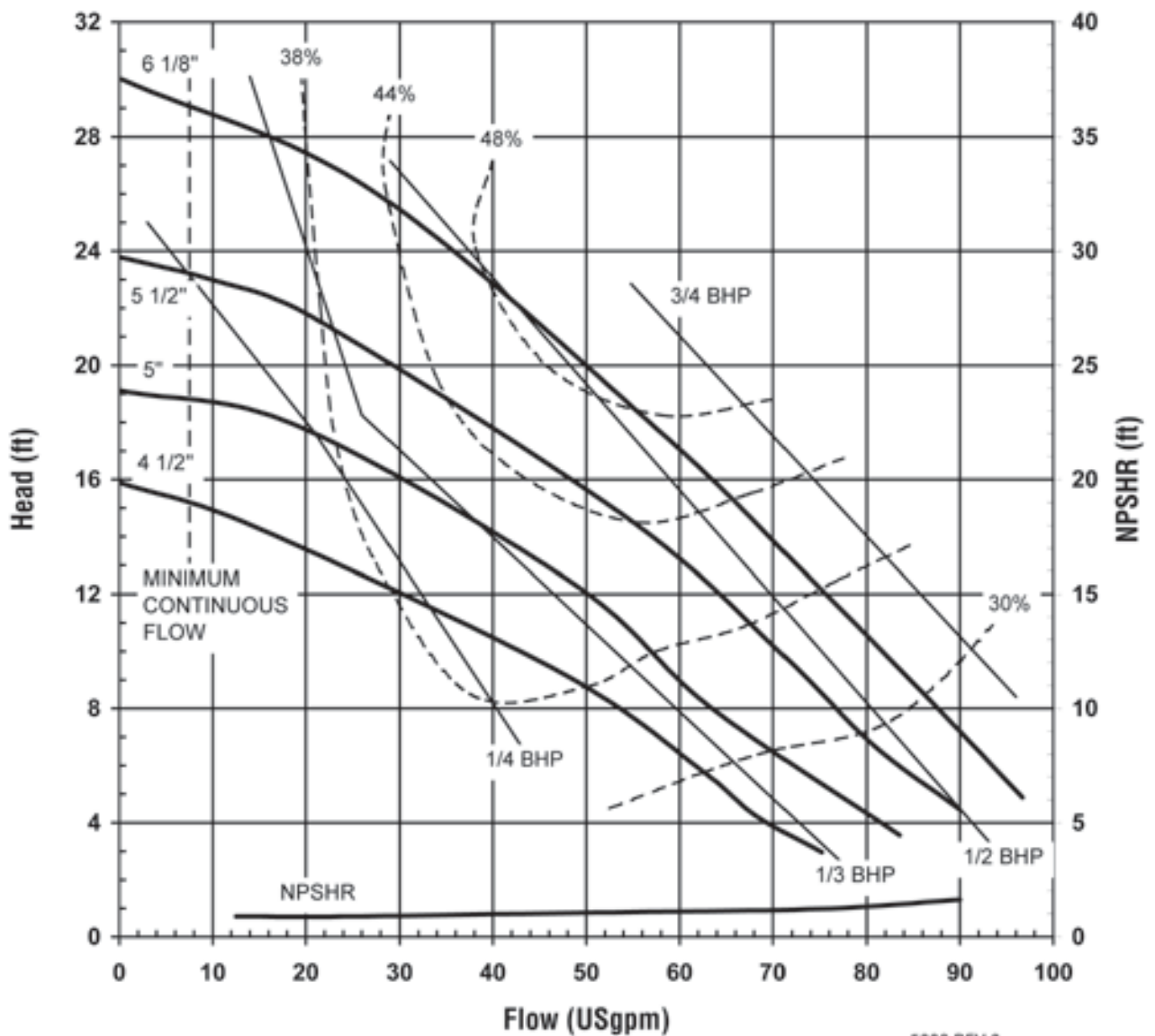

5006 REV 0
08/28/03

MODEL GP22/32

2900 rpm, 50 Hz

Suction: 2" FNPT/3" FLANGE

Discharge: 2" MNPT/2" FLANGE

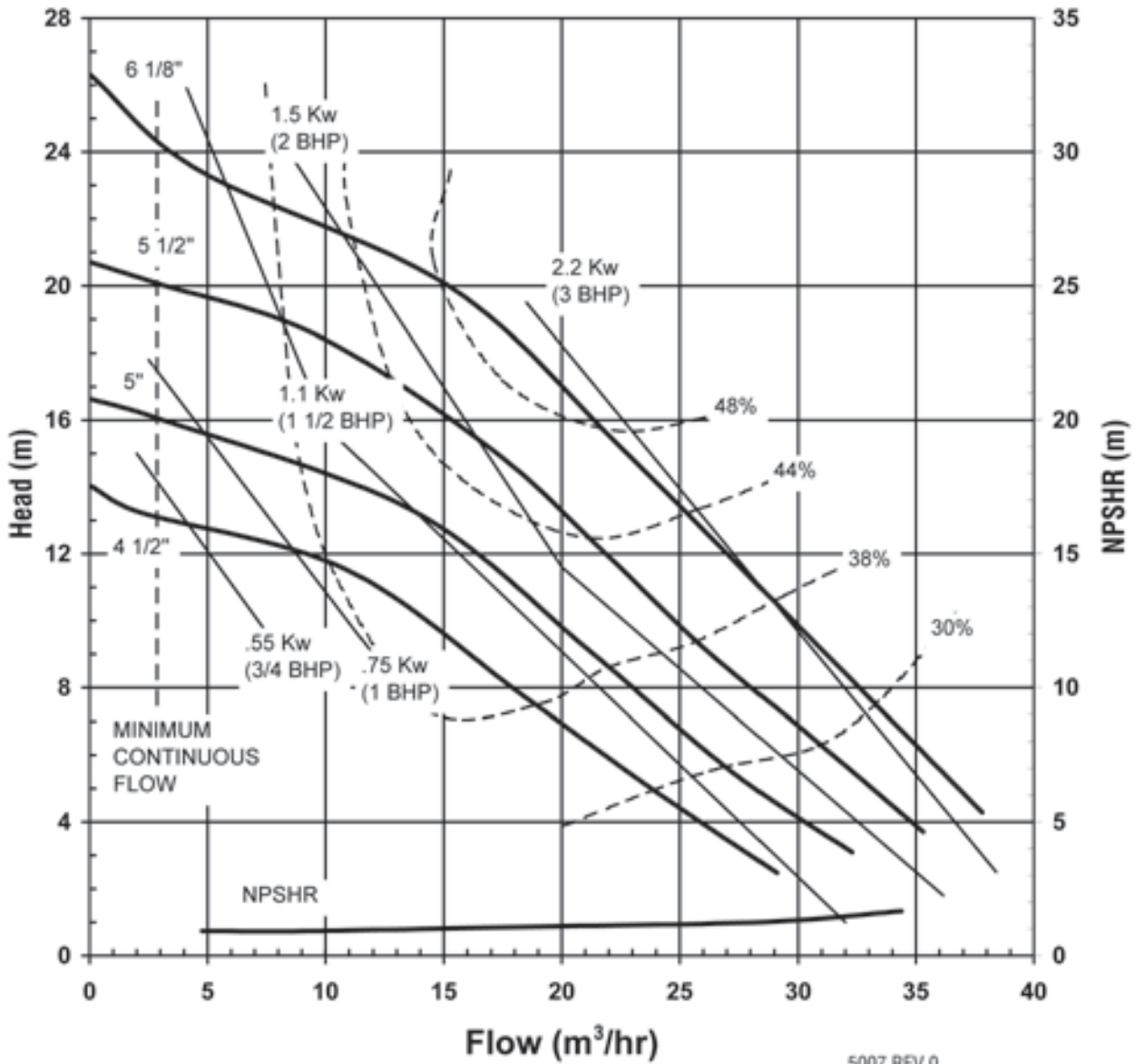

5007 REV 0
08/28/03

MODEL GP22/32

1450 rpm, 50 Hz
Suction: 2" FNPT/3" FLANGE
Discharge: 2" MNPT/2" FLANGE

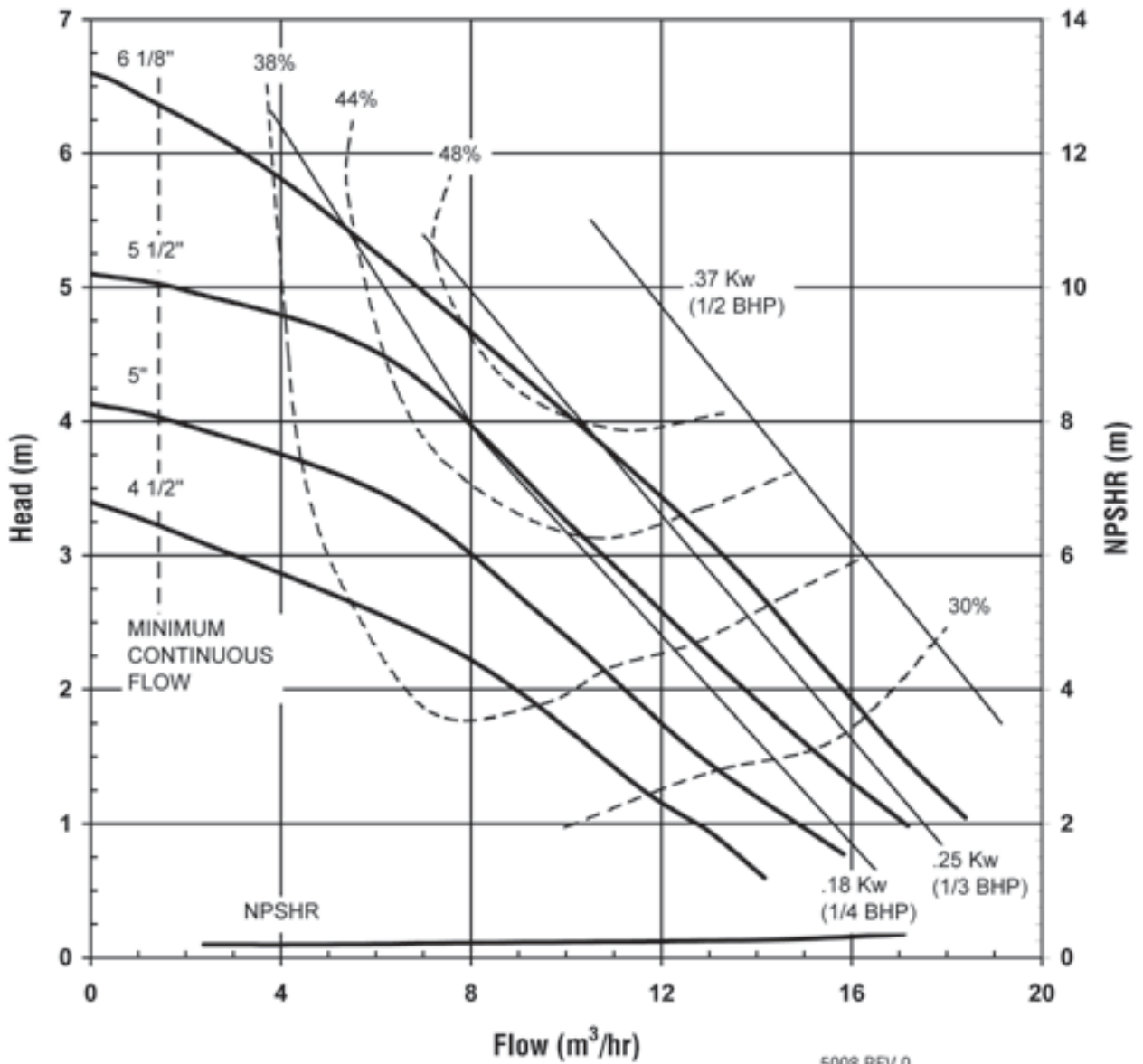

5008 REV 0
08/28/03



FINISH THOMPSON INC.

921 Greengarden Road • Erie, PA 16501-1591 U.S.A.
Ph 814-455-4478 • Fax 814-455-8518
Email fti@finishthompson.com • www.finishthompson.com

FTI Sales 800-934-9384 (USA & Canada)
Literature ID Number FT03-890, Rev 0